



OPERATING INSTRUCTIONS

DCX DATA LOGGER



Table of contents

Product overview	3
Overview of structural designs, Series DCX	4
Measuring principle for Series DCX	5
General	
Level measurement	
Relative pressure measurement (VG)	
Absolute pressure measurement (SG)	
Absolute/absolute pressure measurement (A/A)	
Level measurements in closed receptacles	
Functionality of the Series DCX data logger	8
Data memory	
Installation instructions	9
Important information	
Guidelines on safe and efficient use	
Warranty conditions	
Data for repair and replacement	
Disposal of old electrical equipment and batteries / rechargeable batteries	
Fitting instructions	11
Requirements for the location	
Installation in level tubes	
Water level configuration	
Installation of relative data logger (-VG versions)	
Configuring and reading the DCX	
DCX time	
Verifying measured data	
Device memory	
Maintenance	16
Battery	
Changing the battery, Series DCX	
Watertightness	
Rechargeable battery	
Ventilation diaphragm	
Moisture absorber cartridge	
Cleaning	19
Cleaning the level sensor	
Cleaning the air pressure sensor (-AA versions)	
Calibration	20
Setting the zero point	
Testing by the manufacturer	
Level measurement with pressure sensors	20
Overview of DCX	22
Accessories	26

Product overview

The data loggers in Series DCX are autonomous, battery-powered data collectors which can measure the water level (water column, i.e. pressure) and temperature over lengthy periods.

Series DCX is designed for level measurements and is generally used for long-term data acquisition in applications with brackish water, salt water or fresh water.

Series DCX is also available with a connecting thread for process applications.

Various versions are available in Series DCX. The standard material is stainless steel, 316L (DIN 1.4435). For added resistance to media, the logger can be manufactured to order from Hastelloy or titanium as options. The key distinguishing features of products in Series DCX are their measuring methods and the diameter of the probe.

DCX-22 AA

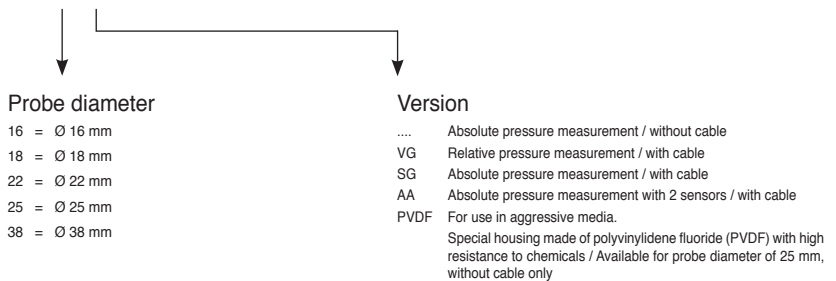

Maximum pressure ranges and cable lengths

Designation	Measuring principle	Max. pressure range	Max. mH2O	Max. cable length**
DCX-16	absolute	0,8...11 bar abs.	0...100 mH2O	–
DCX-16 VG	relative	0...10 bar rel.	0...100 mH2O	500 meters
DCX-16 SG	absolute	0,8...11 bar abs.	0...100 mH2O	500 meters
DCX-18	absolute	0,8...11 bar abs.	0...100 mH2O	–
DCX-18 VG	relative	0...10 bar rel.	0...100 mH2O	500 meters
DCX-18 SG	absolute	0,8...11 bar abs.	0...100 mH2O	500 meters
DCX-22	absolute	0,8...11 bar abs.	0...100 mH2O	–
DCX-22 Baro	absolute	0,8...1.3 bar abs.	0...100 mH2O	–
DCX-22 VG	relative	0...10 bar rel.	0...100 mH2O	500 meters
DCX-22 SG	absolute	0,8...11 bar abs.	0...100 mH2O	500 meters
DCX-22 AA	absolute/absolute	0,8...11 bar abs.	0...100 mH2O	80 meters
DCX-25 PVDF	absolute	0,8...11 bar abs.	0...100 mH2O	–
DCX-38 VG	relative	0...300 mbar rel.	0...3 mH2O	500 meters

** For other system lengths, please contact our sales staff

Overview of structural designs, Series DCX

Different versions of the autonomous data loggers in Series DCX are available from KELLER in order to meet the requirements for the measuring point, the on-site environmental conditions and the fluid to be measured:

Series DCX-16

- probe diameter 16 mm



Series DCX-18

- probe diameter 18 mm
- powered by rechargeable battery
- completely welded in
- screw-on cable



Series DCX-22

- probe diameter 22 mm
- AA version
- high-accuracy version
- customized versions on request

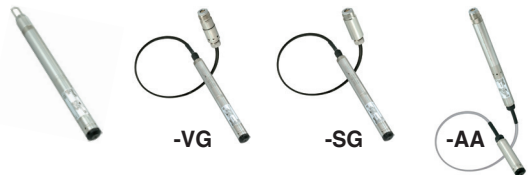

Series DCX-25 PVDF

- probe diameter 25 mm
- for use in aggressive media
- Special housing made of polyvinylidene fluoride (PVDF) with high resistance to chemicals. Pressure sensor in Hastelloy or titanium, according to choice



Series DCX-38 VG

- probe diameter 38 mm
- to measure low pressures or levels (measuring ranges: 0,5 / 1 / 3 mWS)
- capacitive measuring cell with gold-plated ceramic diaphragm
- Moisture absorber cartridge included in scope of delivery



Measuring principle for Series DCX

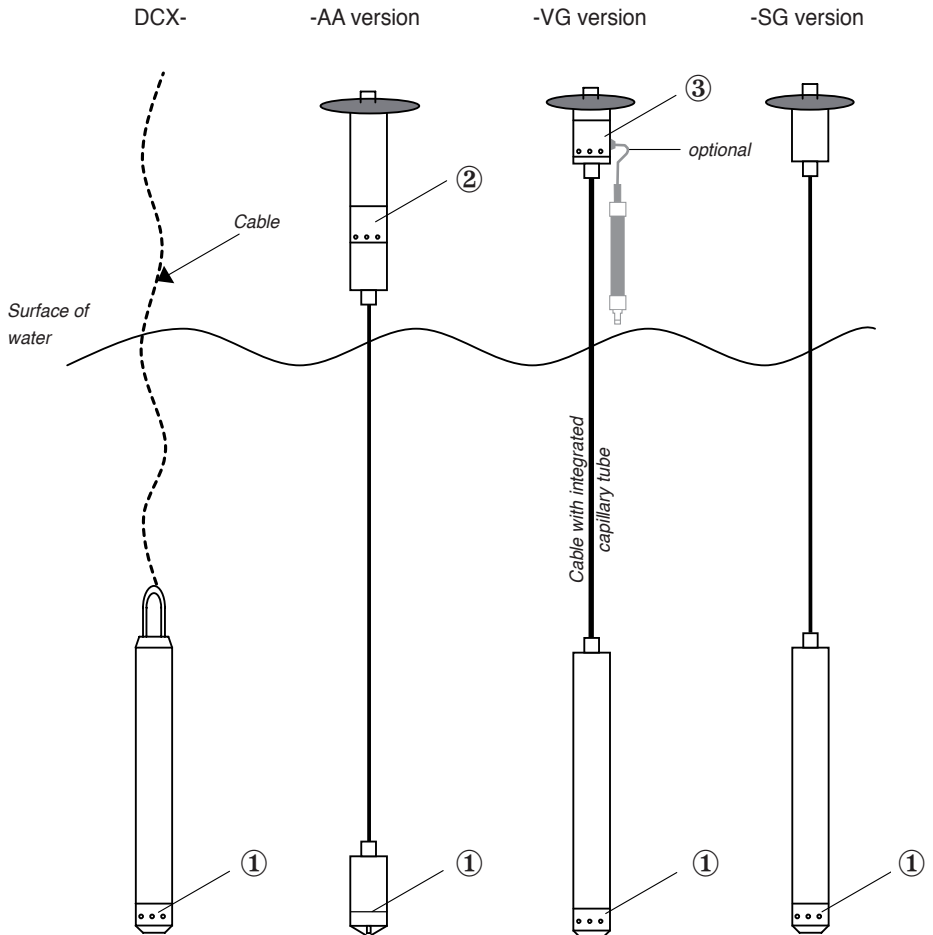

① Level sensor

P1 = medium pressure [bar]
TOB1 = medium temperature [°C]

② Air pressure sensor

P2 = air pressure [bar]
TOB2 = air temperature [°C]

③ Reference aperture

For physical compensation
of the ambient pressure (air pressure)

General information

Fluctuations in the groundwater level (or the levels of other fluids) can be determined and located precisely by measuring the prevailing (hydrostatic) pressure at a defined depth below the surface of the water. To convert the pressure [bar] into the water column level [mWS], it is only necessary to know the density of the fluid.

Example pure water (H₂O): 100 mbar \approx 1,02 mWS

$$h = \frac{p}{\rho \cdot g} = \frac{\text{N/m}^2}{\text{kg/m}^3 \cdot \text{m/s}^2} = \text{mWS}$$

p = hydrostatic pressure (0,1 bar = 10,000 N/m²)

ρ = density (kg/m³)

g = gravitational acceleration (m/s²)

h = height of water column (m)

Level measurement

In open systems, i.e. with the classical method of measuring the filling level, the difference between the pressure acting on the level sensor (total pressure) and the ambient pressure acting on the water (air/atmospheric pressure in most cases) is always measured. The pressure difference determined in this way corresponds to the hydrostatic water pressure.

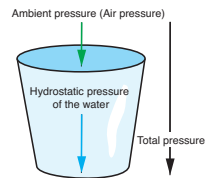

As a result of this measurement method, the level measurement becomes independent of weather-induced fluctuations in air pressure that act on the surface of the fluid. The following methods of compensating for air pressure are available:

Relative measurement method (VG)

In the relative measurement method, the sensor cable has an integrated capillary tube which provides the reference to the ambient air pressure directly on the level sensor. The sensor pressure measured in this way is therefore physically compensated for air pressure.

Advantage: high accuracy and resolution

Disadvantage: high ambient humidity at the measuring point may disrupt or interrupt compensation for air pressure and, in extreme cases, may even damage the level sensor (→ use moisture absorber cartridges)

Absolute measurement method (SG)

With the absolute measurement method, the prevailing total pressure on the level sensor is determined (= air pressure + hydrostatic water pressure). To compensate for the influence of fluctuations in air pressure, a second data logger is positioned on the surface as a barometer.

Advantage: very robust, impervious to ambient humidity

Disadvantage: no integrated air pressure compensation

Absolute/absolute measurement method (A/A)

Total pressure and air pressure are each determined by means of a pressure sensor (A/A technology) and are calculated mathematically in the device by subtracting the two measured values. A sensor cable without a capillary tube is used for this measurement method, and this is why AA systems are highly resistant to the ambient humidity prevailing at the measuring point.

Advantage: very robust, impervious to humidity or flooding

Disadvantage: slight reduction in measurement accuracy because of measurements by two sensors

Level measurements in closed receptacles

For level measurement in closed receptacles/vessels, the internal pressure in the vessel is measured instead of the air pressure. The A/A measurement method is usually selected on account of the humidity prevailing inside the vessel.

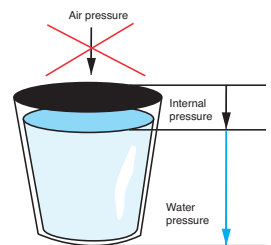

Functionality of Series DCX

Autonomous data loggers in Series DCX record the values measured for pressure and temperature together with the time of each measurement.

The following types of recording and initial conditions are supported:

Recording interval	Constant storage interval	Interval \geq 1 second
	Event-controlled recording	If value is exceeded
		If value is undercut
		If value changes
Initial conditions	Directly after programming is completed	
	Specified, user-defined time	
	Recording starts when a value has been undercut	
	Recording starts when a value has been exceeded	
→ Constant storage interval and event-controlled recording can be used simultaneously		

Data memory

The following table gives an overview of recording periods for various constant measurement intervals. (Data memory size: 2 Mbit)

Type	Interval	Number of channels	Measurement channel	Recording period
DCX-22	1 sec	1	Total pressure	> 15 h 54 min
DCX-22	1 min	1	Total pressure	> 21 h 7 h
DCX-22	1 h	1	Total pressure	> 3 y 6 m
DCX-22	1 sec	2	Total pressure and medium temperature	> 7 h 57 min
DCX-22	1 min	2	Total pressure and medium temperature	> 14 d 4 h
DCX-22	1 h	2	Total pressure and medium temperature	> 2 y 4 m
DCX-22	1 d	2	Total pressure and medium temperature	> 56 y 9 m
DCX-22AA	1 sec	5	Air pressure and air temperature, total pressure and medium temperature, calculated water column level	> 3 h 10 min
DCX-22AA	1 min	5	Air pressure and air temperature, total pressure and medium temperature, calculated water column level	> 7 d 2 h
DCX-22AA	1 h	5	Air pressure and air temperature, total pressure and medium temperature, calculated water column level	> 1 y 2 m
DCX-22AA	1 d	5	Air pressure and air temperature, total pressure and medium temperature, calculated water column level	> 28 y 4 m

Installation instructions

Important information

KELLER website

At www.keller-druck.com, you will find a software section where you can download all KELLER's software programs free of charge. The site contains the latest software versions together with datasheets and operating instructions for the corresponding products.

Service and Support

For service and support, please contact your local dealer or contact us at www.keller-druck.com

Guidelines on safe and efficient use

- Treat the product with care and keep it in a clean place that is free of dust.
- This product must only be used within the specified temperature range
(→ Product datasheet)
- Do not drop or throw the device
- Do not attempt to modify the device



- The sensor pressure diaphragm is sensitive to contact. Do not press the diaphragm in by hand or damage it with sharp objects. Do not direct water jets at the diaphragm.



- Only use this device for non-flammable fluids with no explosion hazard. KELLER offers a series of measurement equipment products suitable for use in areas with explosion hazards (ATEX zones). For more information, please contact our sales staff.



- Aggressive media may damage the product. Make sure that the materials in the product are not attacked by the medium to be measured.



- With relative versions (VG), the end of the cable must be located in a dry environment in order to prevent condensation forming. If the cable ends in a humid environment, it is highly advisable to use moisture absorber cartridges.



- The level measurement sensor must not freeze up in the medium
- Do not glue, block or contaminate any ventilation components as this will substantially impair measurement accuracy.



- Fasten/secure the product so that the logger cannot fall into the measuring point in case of a handling error.

Warranty conditions

The warranty does not apply to faults on the device caused by normal wear, incorrect use or misuse, or failure to comply with KELLER's instructions.

Data security

KELLER assumes no responsibility for data loss of any nature, and shall not pay compensatory damages in case of data loss. Data stored in the product may be lost if the product is repaired or replaced. You should always create a backup of all data stored in the product before releasing it for repair or replacement.

Disposal of old electrical equipment and batteries / rechargeable batteries

To prevent possible damage to the environment or to health due to uncontrolled waste disposal, this product must be separated from other waste and recycled correctly in order to ensure sustainable use of the raw materials. Remove rechargeable batteries that have been installed permanently. Permanently installed rechargeable batteries must be removed only by a waste processing facility or a trained service technician.

Fitting instructions



Requirements for the location

The DCX logger unit is installed in a stable position at the measurement location in order to record a groundwater level.

- If the logger is fully sunk into the ground (e.g. in a sewer shaft), free movement of the water level in the tube must be ensured by above-ground openings (ventilation apertures)
- Lateral movements of the level sensor may cause measuring errors or cable breaks. For these reasons, fit the level sensor in a calm zone or in a suitable protective tube
- On VG versions, the sensor cable contains a capillary tube to compensate for atmospheric pressure. Therefore, position the cable end of VG versions in a dry area or use moisture absorber cartridges



Installation in level tubes



Place the cap lock in position and screw the two grub screws in to prevent it from turning (anti-theft protection)

→ requires a slotted screwdriver, size 2 (not included in the scope of delivery)



Guide the sensor with the sensor cable into the level tube by hand. The sensor cable must be free and extended as it hangs in the level tube; it must not change its position as this would falsify the measurement results.

→ For system lengths of more than 50 m, cable strain relief is recommended, e.g. using a straining clamp (see Accessories)



Screw the matching adapter ring onto the read-out unit. After installation, the adapter ring will lie on the edge of the level cap lock. Secure the logger unit in the adapter ring using the circlip supplied with the product.

→ requires circlip pliers (not included in the scope of delivery)





The DCX logger can be connected locally to a laptop via the interface converter cable.

The Logger 5 software can now be used to configure the device or to transmit the measurement data stored in the DCX to the laptop.



→ Seal the read-out plug with the protective cap

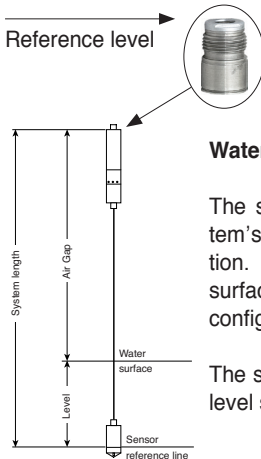

Water level configuration

The surface of the interface plug integrated into the DCX represents the system's reference level. The measuring system is calibrated during installation. For this purpose, the run-off distance is measured (reference level-surface of water, e.g. using a light plummet) and is entered in the water level configuration in the Logger 5 software together with the density of the medium.

The system length is the sum of the hydrostatic water pressure measured at the level sensor and the distance from the reference level that is entered.



After completing work on the measuring point, close the level tube seal by screwing in the hexagon socket.

→ Allen wrench, size 5 (not included in the scope of delivery)

Tip:

To give the measuring point better protection against access, the Allen screw head can be replaced by a screw head that is not available through usual commercial outlets.

Installation of relative data logger (VG versions)



Ambient pressure is compensated physically on VG versions. The ambient pressure is fed to the back of the pressure sensor on the level sensor, via a capillary tube integrated into the sensor cable.

If pressure compensation via the capillary tube is impeded or prevented by contamination or moisture inside the capillary tube, the result of the level measurement will be affected.

Standard version

The pressure compensation aperture is located behind the removable protective tube, which is perforated. This opening for the cable capillary is protected against water penetration by a Goretex® diaphragm.

A thread to insert moisture absorber cartridges is provided on the plug component of VG versions (minimum inner diameter of tube: $\text{\O} 35 \text{ mm}$). It is advisable to use moisture absorber cartridges for measuring points with harsh ambient conditions.

→ section: Maintenance / Moisture absorber cartridge



Moisture absorber cartridge



Version with moisture absorber cartridge (DCX-38 VG)

Configuring and reading the data logger

The DCX is configured and read locally. The DCX is fitted in the measuring point and is connected to a laptop via the interface converter cable.

- The Logger 5 Software Manual is available at www.keller-druck.com

Installing the software

Only connect the DCX and the converter cable to your computer after the software has been installed

- Install the KELLER “Driver K-104 K-114” software
- Install the KELLER “InstallerLogger5” software

→ The connection must not be broken during communication with the DCX (configuration, data read-out). Always close the software program first, and only then unplug the DCX connection.

DCX time

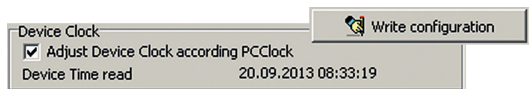

The internal time for the DCX is set by synchronization with your computer's (PC) time. To do this, enable the “Synchronize device time with PC time“ field in the Logger 5 software and then register the configuration on the DCX. The DCX's internal clock does not take account of summer time/winter time changeovers.

UTC (Universal Time Coordinated)

It is advisable to set the computer's time zone to UTC.

Since UTC does not implement time corrections, the DCX's measuring times remain unchanged throughout the year and they can be converted to local time if necessary.

Time zones

If your computer's time is assigned to a time zone (e.g. UTC +2), the PC clock will change over automatically between summer and winter time.

Time corrections / changeovers of the DCX's internal clock only take place if it is synchronized with the computer (“Write configuration”).

Tip:

Configurations are only sent to the logger when you press the “Write configuration” button. You can read the device configuration into the Logger 5 software again to check the DCX settings.

Verifying measured data

Ongoing measurements can be read out with no need to interrupt the measurement sequence.

As you read ongoing measurements, you can set a flag (the measurement in progress will be terminated and a new measurement will be started immediately) or you can continue the ongoing measurement.

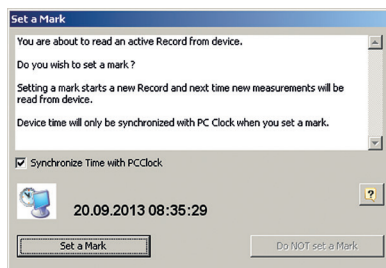

Continue measurement: disable the “Synchronize device time with PC clock” field and select “Do not set flag”.

Tip: Verify online measured values directly, e.g. using a light plummet.

Device memory

Storage space management in the DCX is handled automatically, and the memory cannot be managed or deleted by the user.

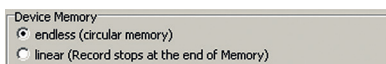

Continuous (circular buffer)

The “Continuous” function (circular buffer) releases the data logger’s entire storage space for the measurement in progress. As soon as the DCX’s storage capacity is reached, the oldest saved measurement values (for the measurement in progress) are overwritten by the latest measured values, until recording is stopped by the user.

Linear

The “Linear” function releases the data logger’s entire storage space for the measurement in progress and terminates recording automatically as soon as the entire memory has been filled with entries.

Data read in

Measured data that are read via the Logger 5 computer software are stored automatically on the computer in a directory that can be freely chosen.

Maintenance

Dry the DCX thoroughly before opening it and make sure that the surrounding area is dry while handling the device. Check all the sealing rings for signs of wear, dirt and damage before using the logger unit again.

Battery

The battery status is not measured; instead, it is calculated using the averaged power consumption. If the battery is changed or in case of a “Power on” reset, the display is reset to 100%. **This also happens if the same battery is inserted again, or if a discharged battery is inserted.**

To ensure that the logger operates reliably, it is advisable to replace the battery as soon as its capacity falls below 30%, or after 5 years of operation.

Changing the battery, Series DCX

Type designation	Supply	Battery type	KELLER product no.
DCX-16	Battery	Lithium battery (type AAA)	557005.0017
DCX-22	Battery	Lithium battery (type AA)	557005.0006
DCX-25 PVDF	Battery	Lithium battery (type AA)	557005.0006
DCX-38 VG	Battery	Lithium battery (type AA)	557005.0006

→ DCX-18: power is supplied by a rechargeable battery (cannot be exchanged)



Battery DCX-16
Lithium battery (type AAA)
KELLER product no. 557005.0017



Battery Series DCX
Lithium battery (type AA)
KELLER product no. 557005.0006

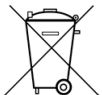

Batteries must never be disposed of in normal household waste. To prevent possible damage to the environment or to health due to uncontrolled waste disposal, this product must be separated from other waste and recycled correctly in order to ensure sustainable use of the raw materials.

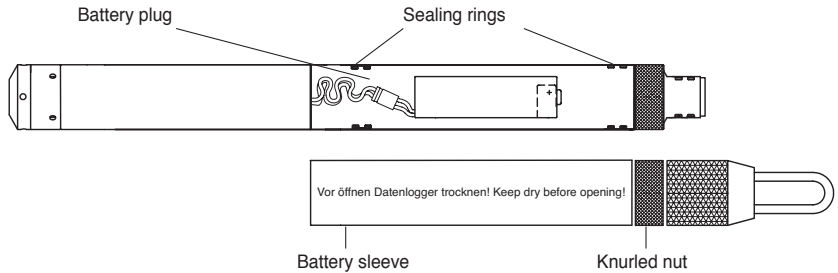

To replace the battery, first unscrew the knurled nut and then pull off the battery sleeve. Carefully disconnect the battery from the plug and replace it.

After changing the battery, guide the plug into the opening in the sleeve, push the battery in and fix it in the clip. Check the sealing rings. Re-fit the battery sleeve, knurled nut and fixture.

Check the configuration (time, measurement interval, etc.) of the DCX via the Logger 5 software before using the product.

Watertightness

Products in the Series DCX logger are dustproof and are protected against the effects of immersion in water (according to the pressure range).

The products are also protected against water splashes in the area of the read-out component.

Exceptions: AA products: may be flooded for brief periods
DCX-22: continuous/long-lasting immersion

→ Please consult the datasheet for the precise specifications.

Check that all sealing rings are clean and undamaged, and that the battery compartment cover is firmly closed so that the Series DCX device is watertight.

Rechargeable battery

Type DCX-18 is powered by a rechargeable battery which can only be charged using interface cable K-114M. The rechargeable battery is welded into the device and cannot be exchanged. The status of the rechargeable battery is determined by measuring its voltage. Avoid letting it discharge to a value of less than 10%. If the DCX is not being used, recording should be stopped and the rechargeable battery should be recharged once per year to prevent total discharge.

Type of charging	Supply	System length	Charging current (rechargeable battery)	Charge time (full charging)
normal	USB	max. 20 m	90 mA	~ 8.5 h
fast	Power unit	max. 100 m	790 mA	~ 1 h

Ventilation diaphragm (for VG versions only)

The diaphragm used for ventilation generally requires no maintenance. The ventilation function of the diaphragm is impaired by matter adhering to or contaminating the ventilation aperture, or by contact between the diaphragm and solvents, to such an extent that it may be necessary to replace the diaphragm. Test measurements are carried out to verify the pressure compensation function.

Tip:

If blowing into the ventilation element during online measurements causes the value to change visibly, the ventilation diaphragm is in proper working order.

Moisture absorber cartridges (optional)

The condition of the moisture absorber cartridge can be determined from the coloration of the granulate. Blue = granulate is dry, pink = granulate is moist.

The granulate can be regenerated for re-use. To do this, pour the granulate from the cartridge into a suitable container and dry it for 1 hour at 210 °C. The granulate releases moisture into the surrounding environment and takes on a blue color again. After drying, the granulate should be poured back into the absorber cartridge while it is still warm.

Note: The color of the granulate is less marked after regeneration than before because the indicator inside the granulate particles migrates.

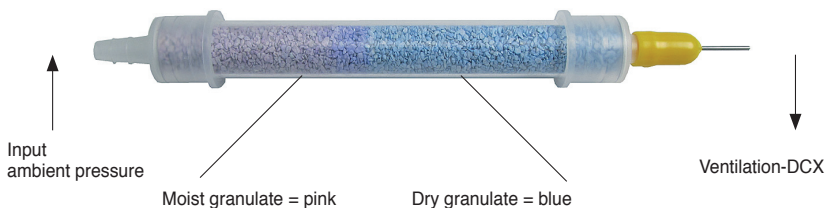

Cleaning

If the data logger is used in severely contaminated media, the pressure sensor must be checked for contamination from time to time, and must be cleaned as necessary. Never use sharp-edged tools such as screwdrivers, and never apply pressure at any point on the diaphragm.

Cleaning the level sensor

The protective cap over the pressure sensor on the level sensor can be removed by hand. Then rinse the sensor in flowing lukewarm water.

The pressure sensor diaphragm is very sensitive.

Do not touch the diaphragm!



Cleaning the air pressure sensor (-AA versions)

To clean the pressure sensor as thoroughly as possible, remove the knurled nut, battery sleeve and the protective sleeve of the sensor, and then re-install the battery sleeve, the protective cap for the interface plug and the knurled nut (without the protective sleeve for the sensor) so that the electronics are protected against water and moisture.

Rinse the sensor with clean lukewarm water. After cleaning and before fitting the sleeves, make sure that all parts are dry.

The pressure sensor diaphragm is very sensitive.

Do not touch the diaphragm!



Calibration



Setting the zero point

The pressure sensors built into the logger unit can be calibrated by the user. It may be necessary to recalibrate the pressure sensors, for example after maintenance work, if the measurement set-up is changed, or after the measuring station has been operated for a year or more.

Calibration is carried out with the Logger 5 software.

Recommended interval between calibrations: 1–2 years.

When carrying out a calibration, note that the sensors must be checked/calibrated in the same positions as they occupy in the measuring point (usually upright) and they must be positioned next to each other at the same level.

Testing by the manufacturer

The DCX may also be sent to KELLER AG für Druckmesstechnik in order to verify its measurement accuracy or for calibration. The following test options may be chosen: simple check on the DCX without documentation, internal check with documentation (5- or 11-point test protocol) or an internal check followed by external certification (DKD [German Calibration Service] or SCS [Swiss Calibration Service] calibration certificate).

(Charges are payable for checks/verifications, calibrations, protocols and certificates)

Level measurement with pressure sensors

Series DCX devices measure and store the hydrostatic pressure of a fluid in bar. The density of the medium has a decisive influence on the conversion of the pressure [bar] to the water column level [mWS]. The height of the water column is calculated with the following formula in the Logger 5 software:

$$h = \frac{p}{\rho \cdot g} = \frac{10000 \text{ N/m}^2}{998,207 \text{ kg/m}^3 \cdot 9,80 \text{ m/s}^2} = 1,021 \text{ mWS}$$

P = hydrostatic pressure (0,1 bar = 10'000 N/m²)

ρ = water density (kg/m³) = 998,207 kg/m³ @ 20°C

g = gravitational acceleration (= 9,80665 m/s²)

h = height of water column (m)

Density [ρ] of the measured medium

The density of fluids is temperature dependent. The density of most fluids decreases in linear proportion to the temperature. However, water reaches its highest density at 3.98 °C; above and below this temperature, the density of water decreases. This phenomenon is also referred to as the “density anomaly of water”.

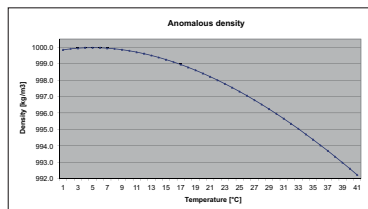

Make sure that the correct density of the measured medium is entered in the logger software in order to calculate the level.

The density entered in the logger software is static. Changes in the temperature of the measured medium and the associated change in density are not taken into account when calculating the water level because this could result in misinterpretations of the measurement result on account of the heterogeneous temperature distribution in bodies of still water.

In normal cases, the temperature distribution is heterogeneous, so the temperature dependency can be neglected. In case of homogeneous temperature distribution and major temperature changes, however, a conversion error between pressure [bar] and level [mWS] occurs due to the density that is stored as a static value.

Temp. [°C]	Pressure [bar]	Density [kg/m³]	Calculated water level	Error at 5 mWS [cm]
4	0,5	999,975	5,0987 m	0 cm
10	0,5	999,702	5,1001 m	+ 0,14 cm
15	0,5	999,103	5,1032 m	+ 0,45 cm
20	0,5	998,207	5,1077 m	+ 0,9 cm
25	0,5	997,048	5,1137 m	+ 1,5 cm
30	0,5	995,65	5,1209 m	+ 2,22 cm

(Water, temperature range 0...30 °C, $p_n = 1013$ kPA).

DCX overview

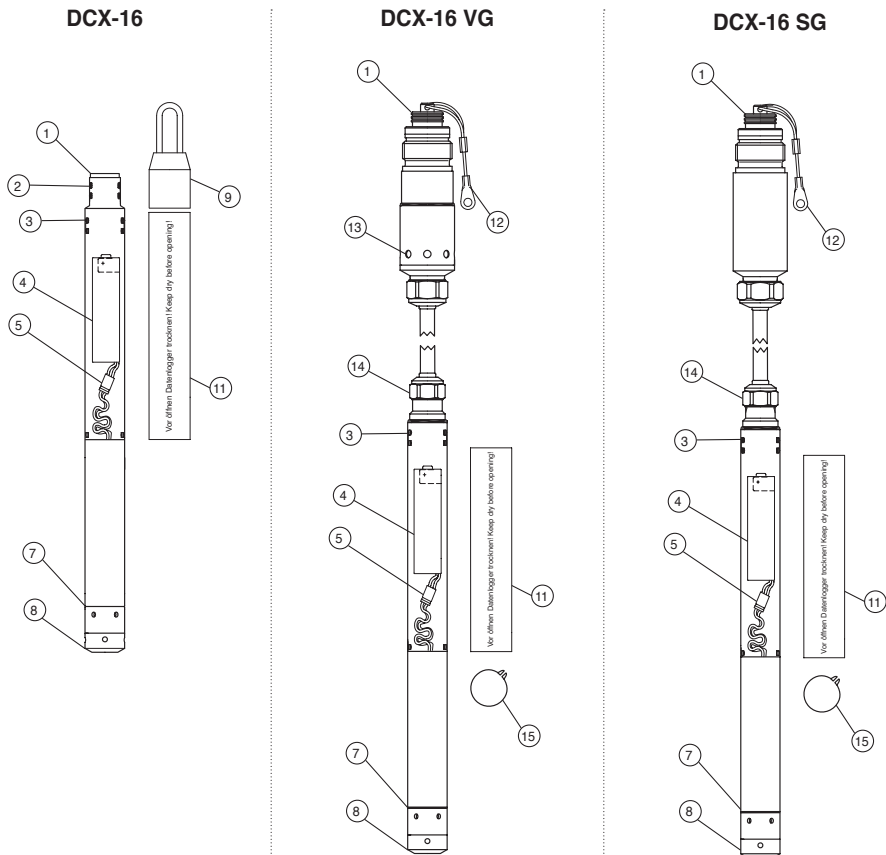

No.	Designation
1	interface plug RS485
2	Sealing ring for interface plug
3	Sealing ring for battery compartment
4	DCX-22...38 VG: AA lithium battery
4	DCX-16: AAA lithium battery
5	Battery plug
6	Air pressure sensor
7	Sensor reference line
8	End cap
9	Fixture with hook to secure the suspended cable

KELLER product numbers are shown in the list of accessories (starting on page 26).

DCX-18

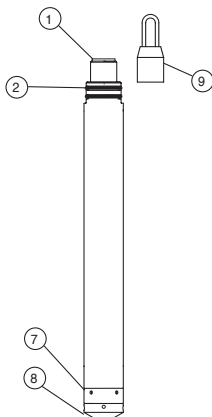

DCX-18 VG

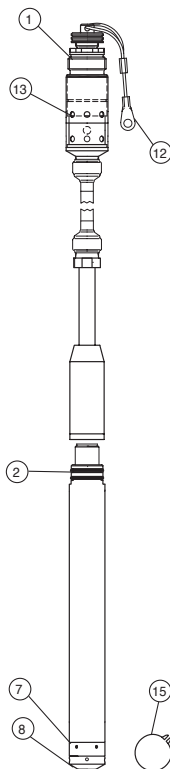

DCX-18 SG

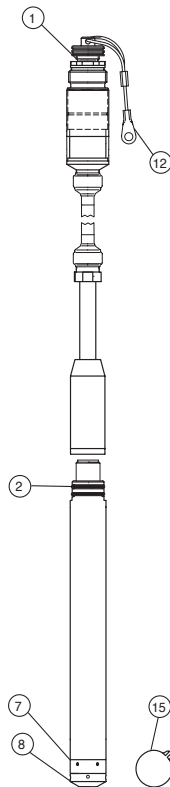

No.	Designation
10	Knurled nut
11	Battery sleeve
12	Cap lock for interface plug
13	Ventilation aperture (only present on VG versions)
14	Screw nut
15	Circlip
16	Sealing ring for battery compartment DCX-25 PVDF, 15,5 x 1,5 NBR
17	Sealing ring for battery compartment DCX-25PVDF, 16 x 2 Viton®
18	Plastic housing component
19	Humidity absorber cartridge, opt. Included in the scope of delivery for DCX-38

KELLER product numbers are shown in the list of accessories (starting on page 26).

DCX-22

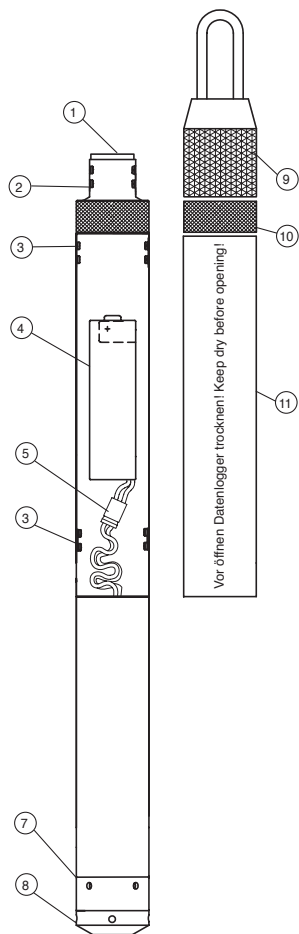

DCX-22 AA

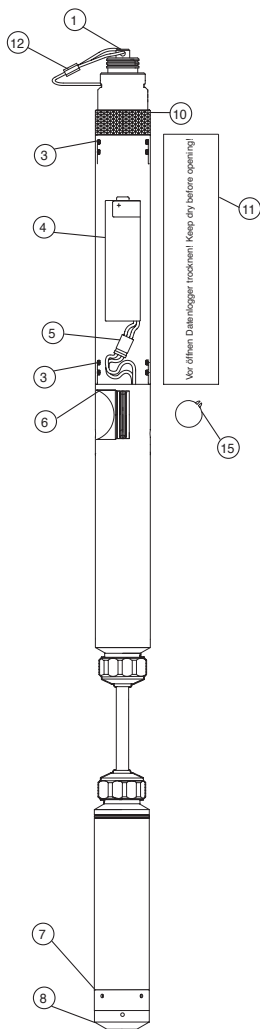

DCX-22 VG

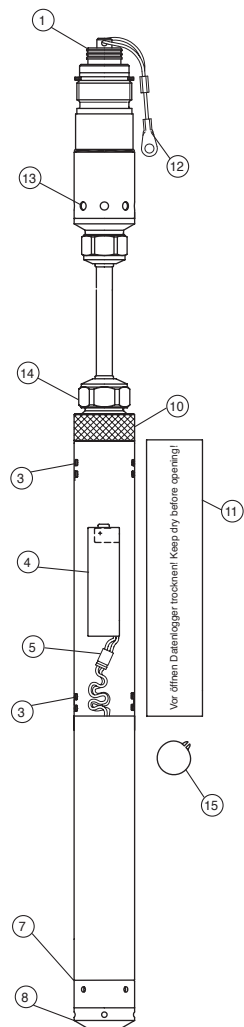

DCX-22 SG

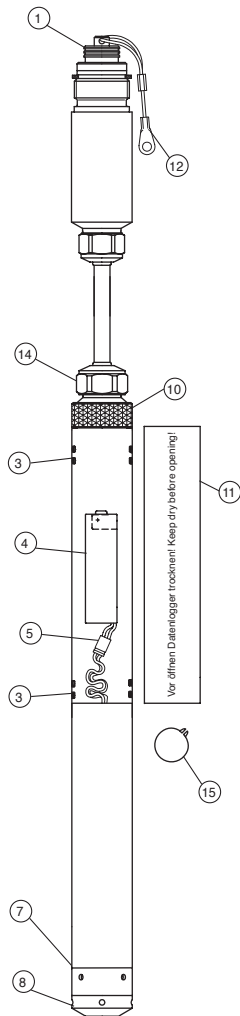

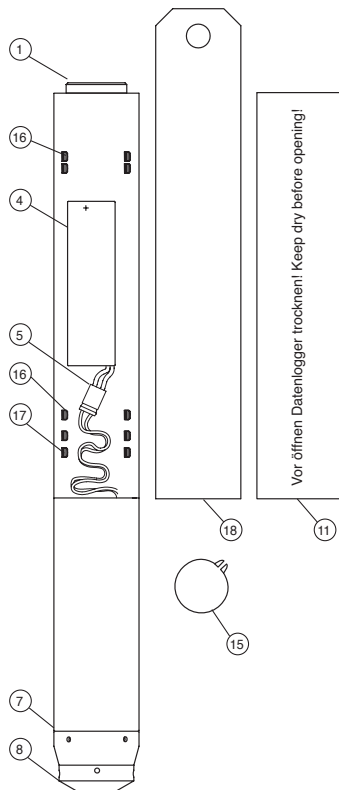

DCX-25 PVDF



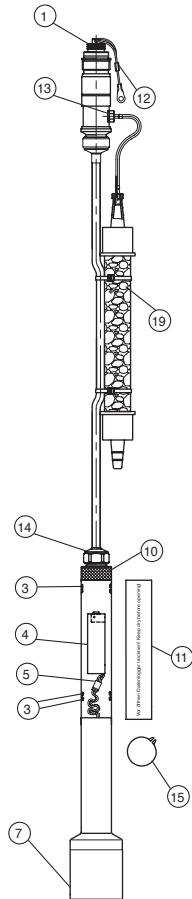





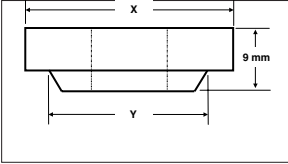

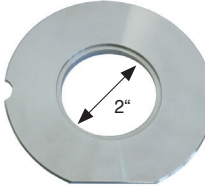
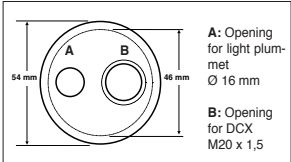
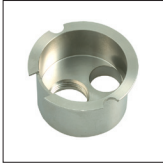
DCX-38 VG















Accessories



DESCRIPTION	SCOPE OF DELIVERY	PRODUCT NO.																																																		
<p>Software CD</p> <p>Contains all KELLER software including USB driver for K-114/K-104</p> <p>Can be downloaded free of charge at: www.keller-druck.com</p>	Supplied with product	<p>750505.0001</p> 																																																		
<p>Adapter rings for DCX</p> <p>(can be supplied as an option)</p> <p>Suitable for</p> <ul style="list-style-type: none"> - DCX-16 SG/VG - DCX-18 ECO (SG/VG) - DCX- 22 SG/VG - DCX-22 AA - DCX-38 VG 	Optional	  <table border="1" data-bbox="684 820 1042 1294"> <thead> <tr> <th colspan="2">Dimensions [mm]</th> <th rowspan="2">Drawing no.</th> <th rowspan="2">Product no.</th> </tr> <tr> <th>x</th> <th>y</th> </tr> </thead> <tbody> <tr><td>30</td><td>25</td><td>33386 pos. 1</td><td>506810.0006</td></tr> <tr><td>40</td><td>25</td><td>33386 pos. 2</td><td>506810.0018</td></tr> <tr><td>49</td><td>39</td><td>33386 pos. 3</td><td>506810.0015</td></tr> <tr><td>55</td><td>50</td><td>33386 pos. 4</td><td>506810.0019</td></tr> <tr><td>60</td><td>55</td><td>33386 pos. 5</td><td>506810.0014</td></tr> <tr><td>65</td><td>55</td><td>33386 pos. 6</td><td>506810.0020</td></tr> <tr><td>35</td><td>32</td><td>33386 pos. 8</td><td>506810.0022</td></tr> <tr><td>37</td><td>32</td><td>33386 pos. 9</td><td>506810.0025</td></tr> <tr><td>42</td><td>32</td><td>33386 pos. 10</td><td>506810.0026</td></tr> <tr><td>76</td><td>32</td><td>33386 pos. 11</td><td>506810.0027</td></tr> <tr><td>125</td><td>32</td><td>33386 pos. 12</td><td>506810.0030</td></tr> </tbody> </table>	Dimensions [mm]		Drawing no.	Product no.	x	y	30	25	33386 pos. 1	506810.0006	40	25	33386 pos. 2	506810.0018	49	39	33386 pos. 3	506810.0015	55	50	33386 pos. 4	506810.0019	60	55	33386 pos. 5	506810.0014	65	55	33386 pos. 6	506810.0020	35	32	33386 pos. 8	506810.0022	37	32	33386 pos. 9	506810.0025	42	32	33386 pos. 10	506810.0026	76	32	33386 pos. 11	506810.0027	125	32	33386 pos. 12	506810.0030
Dimensions [mm]		Drawing no.	Product no.																																																	
x	y																																																			
30	25	33386 pos. 1	506810.0006																																																	
40	25	33386 pos. 2	506810.0018																																																	
49	39	33386 pos. 3	506810.0015																																																	
55	50	33386 pos. 4	506810.0019																																																	
60	55	33386 pos. 5	506810.0014																																																	
65	55	33386 pos. 6	506810.0020																																																	
35	32	33386 pos. 8	506810.0022																																																	
37	32	33386 pos. 9	506810.0025																																																	
42	32	33386 pos. 10	506810.0026																																																	
76	32	33386 pos. 11	506810.0027																																																	
125	32	33386 pos. 12	506810.0030																																																	

DESCRIPTION	SCOPE OF DELIVERY	PRODUCT NO.
<p>Cap lock, DCX 2" 3" 4" 5" 6"</p>	<p>Optional</p>	<p>506815.0009 506815.0040 506815.0041 506815.0042 506815.0043</p> 
<p>Adapter ring to match DCX cap lock 3" 4" 5" 6"</p> <p>→ to install the DCX logger in the level tube, an adapter ring (2" pot) is required</p>	<p>Optional</p>	<p>506810.0085 506810.0085 506810.0087 506810.0078</p> 
<p>Adapter ring (2" pot)</p>	<p>Optional</p>	<p>506810.0021</p>  <p>A: Opening for light plummet Ø 16 mm</p> <p>B: Opening for DCX M20 x 1,5</p> 

DESCRIPTION	SCOPE OF DELIVERY	PRODUCT NO.	
End cap for DCX-16	Supplied with product for DCX-16	507205.0033	
End cap for DCX-18	Supplied with product for DCX-18	507220.0109	
End cap for DCX-22 & DCX-25 PVDF	Supplied with product for DCX-22	507220.0001	
Protective cap with filter for DCX-22	Optional	507220.0002	
Battery to match: DCX-16 (AA/SG/VG) Minamoto brand: lithium 3,6 V AAA	Supplied with product for DCX-16	557005.0017	
Battery to match: DCX-22 (AA/SG/VG) Tadiran brand: lithium 3,6 V AA Type: SL-760	Supplied with product for DCX-22	557005.0010	
Battery to match: DCX-22 (AA/SG/VG)/25/38 <u>Models from 2009 onwards:</u> with plug cable Tadiran brand: Lithium 3,6 V AA Type: SL-760	Supplied with product for DCX-22	557005.0006	
Power unit, 15 V (Europa) DC plug Input: 230 VAC Output: 15 VDC, 360 mA Cable length: 1,8 m	Supplied with product for K-114M	309010.0025	

DESCRIPTION	SCOPE OF DELIVERY	PRODUCT NO.	
<p>Plug-type power unit, 15 V (U.K.)</p> <p>DC plug Input: 230 VAC Output: 15 VDC, 360 mA Cable length: 2 m</p>	Supplied with product for K-114M	309010.0087	
<p>Plug-type power unit, 15 V (USA)</p> <p>DC plug Input: 120 VAC Output: 15 VDC, 360 mA Cable length: 2 m</p>	Supplied with product for K-114M	309010.0086	
<p>Auto adapter cable</p> <p>Connection to converter K-104M/K-114M (→ DCX-18)</p>	Optional	309010.0051	
<p>Extension cable "Reference"</p> <p>for DCX-18 (PE cable, Ø 5,8 mm)</p>	Optional	5 meters 602515.0023 10 meters 602515.0024 20 meters 602515.0025 50 meters 602515.0026 100 meters 602515.0027	

DESCRIPTION	SCOPE OF DELIVERY	PRODUCT NO.	
Flange socket for connection socket with hexagon socket screw (Inox/stainless steel M3 x 6) for securing	Supplied with product for DCX-16/DCX-22/DCX-38 VG	508415.0004	
Circlip DIN: 471 (BN: 682) Ø 18 mm	Supplied with product for AA/VG/SG versions	508830.0002	
O-ring, battery compartment and interface plug For type DCX-16 Ø 11 mm x 1,5 mm / Nitrile	Spare part	508610.0007	
O-ring, interface plug For type DCX-18 Ø 13,5 mm x 1,5 mm / Nitrile	Spare part	508610.0055	
O-ring, interface plug For type DCX-22 Ø 13 mm x 1,5 mm / Nitrile	Spare part	508610.0051	
O-ring, battery compartment For type DCX-22/-38 Ø 17 mm x 1,5 mm / Nitrile	Spare part	508610.0024	
O-ring, battery compartment For type DCX-25 PVDF Ø 16 mm x 2 mm / Viton	Spare part	508610.0150	
O-ring, read-out plug For type DCX-25 PVDF Ø 15,5 mm x 1,5 mm / NBR	Spare part	508610.0144	
O-ring, read-out plug For type DCX-25 PVDF Ø 16,5 mm x 1,5 mm / NBR	Spare part	508610.0159	

DESCRIPTION	SCOPE OF DELIVERY	PRODUCT NO.
<p>Interface converter K-103A (not for DCX-18 ECO)</p> <p>For communication between PC and DCX-16/22. Connection to serial interface (converter RS232 – RS485)</p>	Optional	<p>309010.0002</p> 
<p>Interface converter K-114A with Fischer plug/ 5-pin:</p> <ul style="list-style-type: none"> • Supply via USB for a connected end consumer (U-Out = 11,8 VDC / I-Out_{max} = 40 mA) • Optical status and configuration display (LED) • Electrical isolation • Total length: 1,7 m • Software CD and USB connection cable included in scope of delivery 	Optional	<p>309010.0075</p> 
<p>Interface converter K-114M with M12 socket/ 5-pin:</p> <ul style="list-style-type: none"> • Supply/charge via USB (U-Out = 5 V / I-Out_{max} = 100 mA) (fast charging via external power unit, 12...20 VDC) • Optical status and configuration display (LED) • Electrical isolation • Total length: 2,3 m • Software CD, power unit and USB connection cable included in scope of delivery 	Optional	<p>309010.0077</p> 

For the following products

DCX-16 / DCX-18 / DCX-22 / DCX-25 / DCX-38

We hereby declare that the product complies with the most important protection requirements that are defined in the directive of the committee for harmonizing the legal requirements of the member states with regard to electromagnetic compatibility (2004/108/EC).

This declaration applies to all of the above-mentioned items that are marked with the CE symbol and are a constituent of this declaration.

The following standards were used to evaluate the products with regard to electromagnetic compatibility:

EN 61000-6-1: 2007

EN 61000-6-2: 2005

EN 61000-6-3: 2007

EN 61000-6-4: 2007

EN 61326-2-3: 2006

This declaration applies to the manufacturer:

Keller AG, St. Gallerstrasse 119, 8404 Winterthur, Switzerland

submitted by:

Keller GmbH, Schwarzwaldstrasse 17, D-79798 Jestetten

Jestetten, November 12, 2013



H.W. Keller, Director

with legally valid signature

